

6

5

4

3

2

1

### POWER

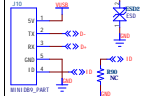

### Charger

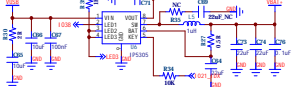

### Battery Protection

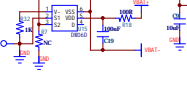

### LDO

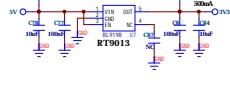

REVISION RECORD			
LTR	ECO NO2	APPROVED	DATE

### IMU

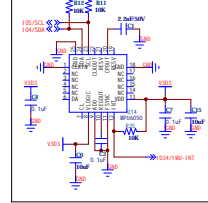

### UART

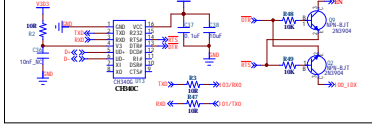

### MCU

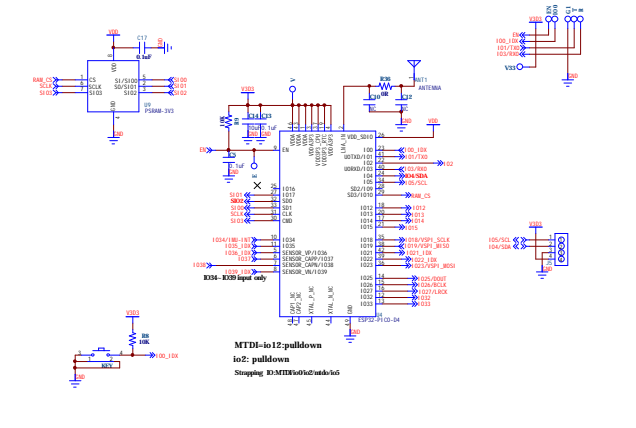

### Voltage Measure

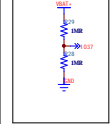

### MEMS MIC

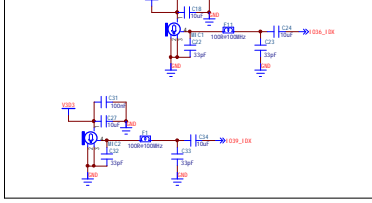

### RGB LEDs

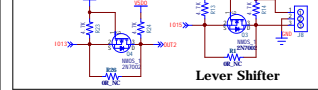

### OUTs

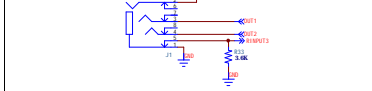

### DECODER/PA

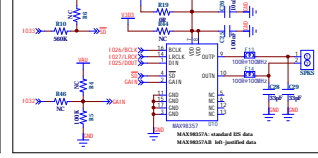

### Temperature&Hmidity

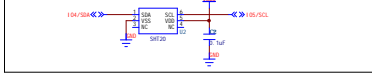

### TF-Card

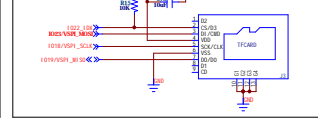

### MARK&HOLE



### TouchKey



DESIGN:	DATE:
Marco YOU	2021/08/22
CHECKED:	DATE:
QUALITY CONTROL:	DATE:
RELEASED:	DATE:

COMPANY:		Mini Technology
TITLE:	Music Fountain	
REV:	A	
SCALE:	1 of 2	

6

5

4

3

2

1

D

C

B

A

D

C

B

A

REVISION RECORD			
LT#	ECO NO.	APPROVED	DATE

DESIGNER:	<b>Marco YOLU</b>	COMPANY:	Mini Technology
CHECKED:	DATE: <b>2018/09/22</b>	TITLE:	<b>Music Fountain</b>
QUALITY CONTROL:	DATE:	ISSUE NO.:	<b>MNT.CD52.A</b>
RELEASED:	DATE: <b>2018/09/11</b>	SCALE:	REV: <b>A</b>
		SHEET: 2 of 2	